

CAMPLUX





RESIDENTIAL INDOOR TANKLESS GAS WATER HEATER

CA318B/CA318W USE & CARE MANUAL



OPTIONAL COLOUR ► WHITE BLACK

 DANGER	CARBON MONOXIDE HAZARD
	<p>This appliance can produce carbon monoxide which has no odor.</p> <p>Using it in an enclosed space can kill you.</p> <p>Never use this appliance in an enclosed space such as a camper, tent, car or home.</p>

DANGER

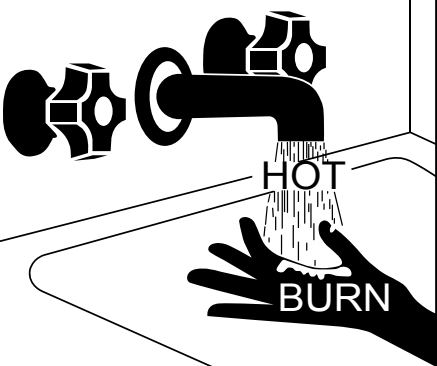

Water temperature over 125°F (52°C) can cause severe burns instantly or death from scalds.

Children, disabled and elderly are at highest risk of being scalded.

See instruction manual before setting temperature at water heater.

Feel water before bathing or showering.

⚠ DANGER

If you smell gas:

1. Shut off gas to the appliance.
2. Extinguish any open flame.
3. If odor continues, keep away from the appliance and immediately call your fire department.

Failure to follow these instructions could result in fire or explosion which could cause property damage, personal injury or death.

⚠ WARNING

Do not store or use gasoline or other flammable vapors and liquids in the vicinity of this or any other appliance.

Keep this appliance away from all combustible materials. Minimum clearances rear at 20 inches, two sides at 40 inches, top at 40 inches. Turn gas off at cylinder valve after use. Disconnect and remove cylinder before storing this appliance indoors.

* Please retain the instruction manual for future reference.

You're All Set!

Thanks for purchasing your new Camplux 12L residential tankless water heater. This convenient, safe and high efficiency product will open the doors to enjoying endless hot water.

We highly suggest you take the time to read through all of the safety and installation procedures in this manual, before attempting to install your new residential water heater.

Always remember we're here for you via our online helpdesk located at www.camplux.com, live chat and toll free at (844)538-7475.



Read this manual

Inside you will find many helpful hints on how to use and maintain your water heater properly. A little preventive care on your part can save you time and money over the life of your water heater. You'll find many answers to common problems in the Troubleshooting Guide. If you review the chart of Troubleshooting Tips first you may not need to call for service.







Read the safety information

To Ensure your safety and the safety of others, we have included important safety warnings throughout this manual.

All safety messages will follow the safety alert symbol and the words: "CAUTION", "DANGER" "WARNING" or "NOTICE".

These words mean:

-  **CAUTION** - A potentially hazardous situation that may result in minor or moderate injury.
-  **DANGER** - An imminently hazardous situation that will result in death or serious injury.
-  **WARNING** - A potentially hazardous situation that could result in death or serious injury and/or damage to property.
-  **NOTICE:** Attention is called to observe a specified procedure or maintain a specific condition.



Warning & You're All Set 1-2

General Safety 3-11

Installing The Water Heater 11-29

Electrical Connection 29-33

Operation 33-36

Maintenance 36-40

Troubleshooting & Error Code 40-41

Replacement Parts & In the Box 42-43

Warranty & Related Residential Models 44-46

CAMPLUX

Important Safety Information Read All Instructions Before Using

Be sure to read and understand the entire Use and Care Manual before attempting to install or operate this water heater. It may save you time and money. Pay particular attention to the Safety Instructions. Failure to follow these warnings could result in serious bodily injury or death. Should you have problems understanding the instructions in this manual, or have any questions, STOP, and get help from a qualified service technician, or the local gas utility.

 **DANGER**

Properly install water heater

Failure to properly install the water heater indoors as outlined in the Installation Instructions in this manual can result in unsafe operation of the water heater. To avoid the risk of fire, explosion, or asphyxiation from carbon monoxide, never operate this water heater unless it is installed properly and has an adequate air supply for proper operation. Be sure to inspect the flue terminal for proper installation at initial start-up and at least annually thereafter. Refer to the Care and Cleaning section of this manual for more information regarding flue terminal inspection.



WARNING

Gasoline, as well as other flammable materials and liquids (adhesives, solvents, paint thinners etc.), and the vapors they produce are extremely dangerous. DO NOT handle, use or store gasoline or other flammable or combustible materials any where near or in the vicinity of a water heater or any other appliance. Be sure to read and follow the labels on the water heater, as well as the warnings printed in this manual Failure to do so can result in property damage, bodily injury or death.

 **DANGER**



<p> Vapors from flammable liquids will explode and catch fire causing death or severe burns.</p> <p>Do not use or store flammable products such as gasoline, solvents or adhesives in the same room or area near the water heater.</p> <p>Keep flammable products:</p> <ol style="list-style-type: none"> 1. Far away from heater 2. In approved containers 3. Tightly closed 4. Out of children's reach 	<p>Water heater has a main burner flame. The main burner flame</p> <ol style="list-style-type: none"> 1. Can come on at any time and 2. Will ignite flammable vapors <p>Vapors:</p> <ol style="list-style-type: none"> 1. Cannot be seen 2. Are heavier than air 3. Go a long way on the floor 4. Can be carried from other rooms to the main burner flame by air currents
<p>Installation:</p> <p>Do not Install water heater where flammable products will be stored or used unless the main burner flame is at least 18" above the floor. This will reduce, but not eliminate, the risk of vapors being ignited by the main burner flame.</p>	
<p>Read and follow water heater warnings and Instructions. If owners manual is missing, contact the retailer or manufacturer.</p>	



WARNING: California Proposition 65

This appliance contains chemicals known to the State of California to cause cancer, birth defects, or other reproductive harm.

If the information in these instructions is not followed exactly, a fire or explosion may result causing property damage, personal injury or death.

Do not discard this manual. Please read carefully and keep in a safe place for future reference.

WARNINGS

- This water heater is not approved for use in manufactured (mobile) homes! Please check local code restrictions pertaining to permanent/fixed installations in manufactured homes in your area.
- Improper installation, adjustment, alteration, service or maintenance can cause death, personal injury, or property damage. Refer to this manual. Installation and service must be performed by a qualified installer, service agency or the gas supplier.

Read All Instructions Before Using

Be sure to read and understand the entire Use and Care Manual before attempting to install or operate this water heater. It may save your time and money. Pay particular attention to the Safety Instructions. Failure to follow these warnings could result in death or serious bodily injury.

Should you have problems understanding the instructions in this manual, or have any questions, STOP and get help from a qualified service technician or the local gas utility

DANGER! Properly install water heater

Failure to properly install the water heater outdoors as outlined in the installation instructions in this manual can result in unsafe operation of the water heater. To avoid the risk of fire, explosion, or asphyxiation from carbon monoxide, never operate this water heater unless it is installed properly and has an adequate air supply for proper operation. Be sure to inspect the flue terminal for proper installation at initial start-up, and at least annually thereafter.



- Combustible construction refers to adjacent walls and ceilings and should not be confused with combustible or flammable products and materials. Combustible materials, such as clothing, cleaning materials, or flammable liquids, should never be stored in the vicinity of this water heater or any gas appliances. Fire or explosion can occur causing death, personal injury, and/or property damage.

NOTICE: When this water heater is supplying general purpose hot water requirements for use by individuals, a thermostatically controlled mixing valve for reducing point of use water temperature is recommended to reduce the risk of scald injury. Contact a licensed plumber or the local plumbing authority for further information.

CAUTIONS

This water heater must only be used with the following water supply system conditions:

- With clean, potable water free of corrosive chemicals, sand, dirt, or other contaminants.
- With inlet water temperature above 32°F(0°C), but not exceeding 118°F(48°C).
- DO NOT reverse the hot and cold water connections. The water heater will not operate.

DANGER! NATURAL GAS AND LIQUEFIED PETROLEUM MODELS SAFETY

Both propane and natural gas have odorants added to aid in detecting a gas leak. Some people may not physically be able to smell or recognize this odorants. If you are unsure or unfamiliar with the smell of propane or natural gas, ask the gas supplier.

Other conditions, such as “odorants fade”, which causes the odorant to diminish in intensity, can also hide or camouflage a gas leak. Always check with commercial leak odorants or soapy water.

- Gas detectors are recommended in propane and natural gas applications and their installation should be in accordance with the detector manufacturer’s recommendations and/or local laws, rules, regulations or customs.
- Water heaters utilizing propane gas are different from natural gas models. A natural gas water heater will not function safely on propane gas and vice versa.



- No attempt should ever be made to convert the water heater from natural gas to propane gas. To avoid possible equipment damage, personal injury or fire, do not connect the water heater to a fuel type not in accordance with the unit data plate; propane for propane units and natural gas for natural gas units. These units are not certified for any other fuel type.
- Propane water heaters should not be installed below grade (for example, in a basement) if such installation is prohibited by federal, state and/or local laws, rules, regulations or customs.
- Propane or propane gas must be used with great caution. It is heavier than air and will collect first in lower areas making it hard to detect at nose level.
- Before attempting to light the water heater, make sure to look and smell for gas leaks. Use a soapy solution to check all gas fittings and connections. Bubbling at a connection indicates a leak that must be corrected. When smelling to detect a gas leak, be sure to sniff near the floor also.
- It is recommended that more than one method, such as soapy solution, gas detectors, etc., be used to detect leaks in gas applications.

NOTICE: If a gas leak is present or suspected:

- DO NOT attempt to find the cause yourself.
- DO NOT try to light any appliance.
- DO NOT touch any electrical switch.
- DO NOT use any phone in your building.
- Leave the house immediately and make sure your family and pets leave also.
- Leave the doors open for ventilation and contact the gas supplier, a qualified service agency or the fire department.
- Stay away from the house(or building) until the service call has been made, the leak is corrected and a qualified agency has determined the area to be safe.
- Follow the steps listed under “WHAT TO DO IF YOU SMELL GAS” found on Page 8 of this manual.

WARNING

- The installation of gas piping must comply with local utility company requirements and/or in the absence of local codes, use the latest edition of National Fuel Gas Code(NFGC), ANSI Z223.1/NFPA 54.
- If inlet gas pressure is out of allowable range (8.0”w.c(2.0kPa)-13.0”w.c.(3.2kPa) for propane gas, a gas pressure regulator must be installed to maintain the allowable inlet gas pressure.
- Should overheating occur or the gas supply fail to shut off, turn off the manual gas control valve to the water heater.



CAUTIONS

- DO NOT attempt repair of electrical wiring, gas piping, burners, vent connectors, or other safety devices. Refer repairs to qualified service personnel.
- Turn off the manual gas shut off valve if the water heater has been subjected to overheating, fire, flood, physical damage, or if the gas supply fails to shut off.
- DO NOT turn on the water heater unless the water and gas supplies are completely opened.

For Your Safety Read Before Operating

WARNING

If you do not follow these instructions exactly, a fire or explosion may result causing property damage, personal injury or loss of life.

- A. This appliance does not have a pilot. It is equipped with an ignition device which automatically lights the burner. Do not try to light the burner by hand.
- B. Before operating, smell all around the appliance are for gas. Be sure to smell next to the floor because some gas is heavier than air and will settle on the floor.

WHAT TO DO IF YOU SMELL GAS

- DO NOT try to light any appliance.
 - DO NOT touch any electrical switch, do not use any phone in your building.
 - Immediately call your gas supplier from a neighbor's phone. Follow the gas supplier's instructions.
 - If you cannot reach your gas supplier, call the fire department.
 - DO NOT return to your home until authorized by the gas supplier or fire department.
- C. Use only your hand to push in or turn the gas control knob. Never use tools. If the knob will not push in or turn by hand, do not try to repair it, call a qualified service technician. Force or attempted repair may result in a fire or explosion.
 - D. Do not use this appliance if any part has been under water. Immediately call a qualified service technician to inspect the appliance and to replace any part of the control system and any gas control which has been under water.



Operating instructions

1. STOP! Read the safety information above on this manual.
2. Turn off all electric power to the appliance.
3. Do not attempt to light the burner by hand.
4. Turn the gas shut off valve located on the outside of the unit clockwise to the “OFF” position.
5. Turn off all electrical power to the appliance.
6. Wait five(5) minutes to clear out any gas. If you smell gas, STOP! Follow “B” in the safety information above on this manual. If you don’t smell gas, go to the next step.
7. Turn the gas shut off valve located on outside of the unit counterclockwise to the “ON” position.
8. Turn on all electric power to the appliance.
9. Set thermostat to desired setting.
10. If the appliance will to operate, follow the instructions “To Turn Off Gas To Appliance” and call your service technician or gas supplier.

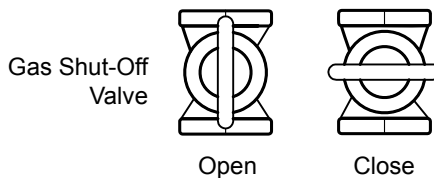

To turn off gas to appliance

1. Turn off all electric power to the appliance if service is to be performed.
2. Turn the gas shut-off valve located on the outside of the unit clockwise to the “OFF” position.

Electrical safety



DANGER

Shock hazard-make sure the electrical power to the water heater is off to avoid electric shock that will result in death or serious personal injury.



WARNINGS

- For your safety, the information in this manual must be followed to minimize the risk of fire, explosion, or electric shock that can result in death, personal injury, and/or property damage.
- Field wiring connections and electrical grounding must comply with local codes or, in the absence of local codes, with the latest edition of the National Electrical Code, ANSI/NFPA 70.

CAUTIONS

- Label all wires prior to disconnecting for service. Wiring errors can cause dangerous and improper operation. Verify correct operation after servicing.
- For your safety, burner inspection and cleaning should be performed only by qualified service personnel.
- Make certain the power to the water heater is OFF before removing the unit cover panel. Expose electrical components and moving parts can cause personal injuries.
- For your safety, DO NOT attempt repair of electrical wiring, gas piping, burners, vent connectors, or other safety devices. Refer repairs to qualified service personnel.

For installations in the state of California

California Law requires that residential water heaters must be braced, anchored or strapped to resist falling or horizontal displacement due to earthquake motions. For residential water heaters up to 52 gallon capacity, a brochure with generic earthquake bracing instructions can be obtained from: Office of the State Architect, 400P Street, Sacramento, CA95814 or you may call 916-445-8100 or ask a water heater dealer.

However, applicable local codes shall govern installation. For residential water heaters of a capacity greater than 52 gallons or tankless style, consult the local building jurisdiction code for acceptable bracing procedures.

Safety precautions

Have the installer show you the location of the gas shut off valve and how to shut it off if necessary. Turn off the manual shut off valve if the water heater has been subjected to overheating, fire, flood, physical damage or if the gas supply fails to shut off.



- Read this manual entirely before installing or operating the water heater.
- Use this appliance only for its intended purpose as described in this Use and Care Manual.
- Be sure your appliance is properly installed in accordance with local codes and the provided installation instructions.
- Part of your water heater unless it is specifically recommended in this manual.
- All other servicing should be referred to a qualified technician.

Installing The Water Heater

Indoor location

- Installation distances may vary by local code. It is the installer's responsibility to verify installation requirement.
- Make sure before installation that the gas type will use is the same type on the data plate.
- The water heater unit should be installed by professionals. Improper installation may cause failure or dangerous conditions such as gas leaking or explosion.
- Water heater cannot be installed in an UN-VENTED bathroom, bedroom, basement, living room, closet, outdoor, stairway or an exit area. If installed in an exit area, it must be at least 16.5ft or more way from the exit.
- Vent pipe should extend from the wall at least 2". The terminal must be at least 1.64 ft away from obstruction, and must be well vented.
- Vent pipe should slope 3° downward, to avoid condensing water and protect from rain entering.
- Vent pipe should avoid direct, strong wind because the downdraft will cause malfunction.
- The unit should be installed far from any blockage, and with plenty of enough space for installation and maintenance. Adequate clearances for servicing must be provided.
- The unit should not be installed in the same room with a gas stove.
- When determining the floor clearance, a clearance of 6" must be maintained between the vent pipe and combustible material. A side wall clearance of 6" and a top clearance of 12" must be maintained.
- The vent pipe can be up 32ft in length with one elbow.
- The vent pipe should be installed with a flame retardant wall thimble. Owner must refer to vent manufacturer's instructions and specifications.
- The power socket connecting the water heater should be grounded properly with a GFCI circuit protector.



- The water heater should not be located in an area where leakage of the heat exchanger or connections will result in damage to the area adjacent to it or to lower floors of the structure. When such areas cannot be avoided it is recommended that a suitable catch pan, adequately drained, must be installed under the water heater. The pan must not restrict combustion airflow.
- The water heater should be installed as close as practical to have termination to minimize vent length and the number of elbows required for venting.
- A gas fired water heater or any other appliance should not be installed in a space where liquids which give off flammable vapors are to be used or stored. Such liquids include gasoline, propane gas (butane or propane), paint or adhesives and their thinners, solvents or removers.
- The unit should be installed far from heat sources, flammable and dangerous materials. Because of natural air movement in a room or other enclosed space, flammable vapors can be carried some distance from where their liquids are being used or stored. The open flame of the water heater's main burner can ignite these vapors causing an explosion or fire which may result in severe burns, death or property damage.
- Raising the water heater will reduce, BUT NOT eliminate the possibility of lighting the vapor of any flammable liquids which may be improperly stored or accidentally spilled.
- If the water heater is installed in a garage, it should be installed so that the direct ignition system and main burner are no less than 18 " above the garage floor.
- Hot and cold water lines should be insulated to conserve water and energy.
- The water heater must be located so it is not subject to physical damage, for example, by moving vehicles, area flooding, etc.
- The water heater should be installed with the proper venting materials and termination suitable for Category III venting. Failure to install and properly vent the water heater to the outdoors as outlined in the Venting Section of this manual can result in unsafe operation. Owner must refer to vent manufacturer's instructions and specifications.
- For other than a direct vent appliance, the appliance must be located as close as practicable to a chimney or gas vent.
- DO NOT install water heater where subject to vibrations or on the road use.
- DO NOT install the water heater in Recreational Vehicles, Mobile Homes, Boats and other Watercraft.
- DO NOT install the water heater near vents for heating or cooling. A minimum of 4 feet should be maintained.
- If the clearances stated on the instruction/warning label, located on the front panel of the heater, install the water heater according to the clearances stated on the manual.



WARNING

Combustible construction refers to adjacent walls and ceilings and should not be confused with combustible or flammable products and materials. Combustible and/or flammable products and materials should never be stored in the vicinity of this or any gas appliance.

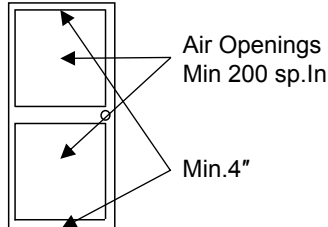

Proper operation of the water heater requires air for combustion and ventilation. Provisions for combustion and ventilation air must comply with referenced codes and standards.

Combustion and Ventilation A:

A confined space is one having a volume of less than 50 cubic feet per 1,000 BTU/Hr of the aggregate input of all appliances within that space.

The air must be supplied through two permanent openings of equal area. One is to be located with 12" above the floor and the other is to be located within 12" below the ceiling.

The minimum net free area of each opening must not be less than one square inch per 1,000 BTU/Hr of the total input rating of all the appliance in the enclosure (but not less than 100 square inches), if each opening communicates with other unconfined areas inside the building.

Buildings of unusually tight construction shall have the combustion and ventilation air supplied from outdoors, or a freely ventilated attic or crawl space. If air is supplied from outdoors, directly or through vertical ducts, there must be two openings located as specified above and each must have a minimum net free area of not less than one square inch per 4,000 BTU/Hr of the total input rating of all the appliances in the enclosure.

If horizontal ducts are used to communicate with the outdoors, each opening must have a minimum net free area of not less than one square inch per 2,000 BTU/Hr of the total input rating of all the appliances in the enclosure. If ducts are used, the minimum dimensions of rectangular air ducts shall not be less than 4".

NOTICE: If the water heater is installed in an unconfined space within a building of conventional frame, masonry or metal construction, infiltration air is normally adequate for proper combustion and ventilation. If the water heater is installed in a confined space, provisions for combustion and ventilation air must be made.



NOTICE: If the duct openings which supply combustion and ventilation air are to be covered with a protective screen or grill, the net free area (openings in the material) of the covering material must be used in determining the size of the openings. Protective screening for the openings **MUST NOT** be smaller than 1/4" to prevent clogging by lint or other debris.

Corrosive atmospheres

The air in beauty shops, dry cleaning establishments, photo processing labs, and storage areas for liquid and powdered bleaches or swimming pool chemicals often contain such halogenated hydrocarbons.

An air supply containing halogenated hydrocarbons may be safe to breathe, but when it passes through a gas flame corrosive elements are released that will shorten the life of any gas burning appliance.

Propellants from common spray cans or gas leaks from A/C and refrigeration equipment are highly corrosive after passing through a flame.

The water heater warranty is voided when failure of the heater is due to operation in a corrosive atmosphere.

NOTICE: The water heater should not be installed near any air supply containing halogenated hydrocarbons.



Nail wall anchor×5pcs



Water tape×1pcs



Wood Screw×5 pcs



Washer X5 pcs



Exposive X2 pcs



Gas connector×1pcs

Check the unit

Inspect the water heater for possible damage. Check the markings on the rating plate of the water heater to be certain the type of gas supplied corresponds to the water heater requirements. Verify all included parts are present (Check details from In The Box at Page 32)

Water supply connections

Plumbing should be carried out by a qualified plumber in accordance with local codes. Use approved plumbing materials and tools only.

Install a check valve between the water heater and the water shut off valve.



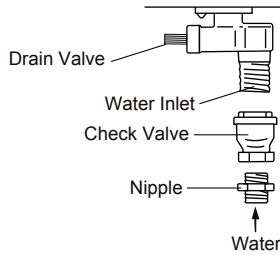

To conserve energy and to prevent freezing, insulate both cold and hot water supply lines. DO NOT cover the drain valves. Install a shut off valve near the inlet of the water heater for service and draining purposes. Before connecting the water supply pipe to the water heater, open the shut off valve and clean out sand, debris, air, caulking material, etc inside the pipe. Connect to the water inlet, then check water flow. Close the shut off valve and clean the water filter.

If a water heater is installed in a close water supply system, such as one having a backflow preventer in the cold water supply line, means shall be provided to control thermal expansion. Contact the water supplier or local plumbing inspector on how to control this situation.

To ensure proper operation of the water heater, the following water pressure guidelines should be followed:

- Operation of the water heater requires the minimum water pressure of 14 PSI and a minimum water flow rate of 0.75 GPM.
- Additional water pressure is required for long pipe runs and outlet fitting(s) water pressure drops.
- To maintain proper performance, ensure sufficient water supply pressure. The Required Water Pressure= Min. Operating Water Pressure (14 PSI)+Pipe Pressure Loss +Faucet and Shower Pressure Loss + Safety Margin (more than 5 PSI)
- To supply hot water to upper floors, additional water pressure (0.44 PSI / FT) must be ensure.
- The measurement should be calculated by the distance between the water inlet of the water heater (ground level) to the hot water faucet (upper floor level).
- Well water systems should be set at a range of 50-60 PSI.
- When the water is supplied from a water supply tank, the height of the tank and the diameter of the pipes and their relation to water pressure, should be taken into consideration. Gravity water pressure is not recom mended.

IMPORTANT: Do not apply heat to the HOT or COLD water connections. Any heat applied to the water supply fittings will permanently damage the internal components of the water heater.



IMPORTANT: Do not apply heat to the HOT or COLD water connections. Any heat applied to the water supply fittings will permanently damage the internal components of the water heater.

NOTICE: If the water flow resistance of a shower head is too high, the burner in the water heater will fail to ignite. Keep the shower head clean from debris that could cause additional pressure drop.

NOTICE: If using mixing valves on the outlet, choose one which prevents cold water pressure from overcoming hot water line pressure.

DO NOT use pipes with smaller diameters than the water supply connection of the water heater.

Be sure to connect the water inlet and the hot water outlet as shown on the water heater. If reversed, the water heater will not function.

Installation of unions or flexible copper connections are recommended on the HOT and COLD water lines, so that the water heater may disconnect easily for servicing if necessary.

In regards to the hot water outlet

- Connections between the water heater and point(s) of use should be as short and direct as possible.
- DO NOT use lead or non-approved plastic pipe.
- To conserve energy and minimize heat loss, insulation of hot water piping is recommended.

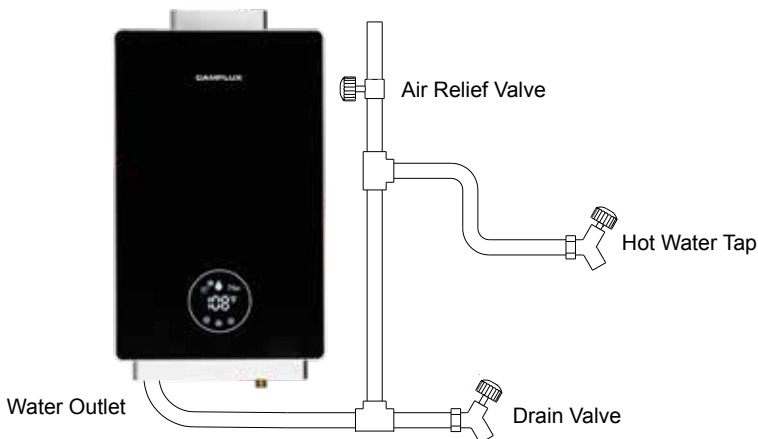

NOTICE: The flow rate of hot water many vary when more than two faucets (appliances, fixtures, etc) are being used simultaneously.

NOTICE: The pipes **MUST** be completely drainable. If the hot water faucets are located at a point higher than the water heater, place a drain valve at the lowest point (see diagram to the left).

Relief Valve

A new pressure relief valve, complying with the Standard for relief Valves and Automatic Gas shut off Devices for hot water supply systems, ANSI Z21.22, must be installed at the hot water outlet connection of the water heater at the time of installation, local codes shall govern the installation of relief valves.

For safe operation of the water heater, must be sure that:

- The pressure rating of the relief valve must not exceed 150 PSI, the maximum working pressure of the water heater as marked on the rating plate.
- The BTU/Hr rating of the relief valve must equal or exceed the BTU/Hr input of the water heater as marked on its rating plate.
- No valve of any type should be installed between the relief valve and the water heater.
- Discharge from the relief valve should be piped to a suitable drain to eliminate potential water heater damage. Piping used should be of a type approved for the distribution of hot water.
- Hot and cold water lines should be insulated up to the water heater.
- The discharge line must be **NO SMALLER** than the outlet of the valve and must pitch downward to allow complete drainage (by gravity) of the relief valve and discharge line.
- The end of the discharge line should not be threaded or concealed and should be protected from freezing. No valve of any type, restriction or reducer coupling should be installed in discharge line.

NOTICE: The diagram below illustrates a pressure only relief valve. If local codes require a combination temperature and pressure relief valve be installed, an extension piece may be needed.

NOTICE: Manual operation of relief valves should be performed at least once a



year. Turn off the electrical power and gas shut off valve. Lift and release lever on the relief valve and check the manual operation of the relief valve. You should take precaution to avoid contact with the hot water coming out of the relief valve and to prevent water damage.

NOTICE: If the relief valve on the system discharges periodically, this may be due to thermal expansion in a closed water supply system. Contact the water supplier or local plumbing inspector on how to correct this situation. Do not plug the relief valve.

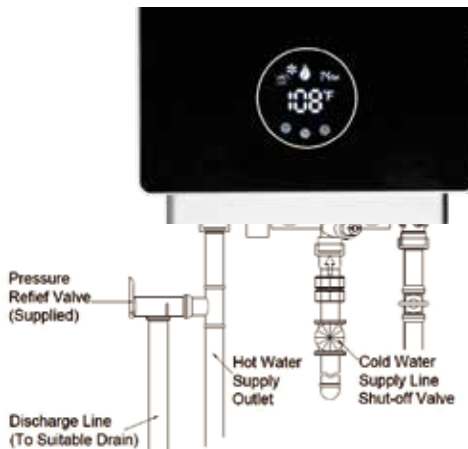

Gas Supply

⚠ WARNING: Do not attempt to convert this water heater for use with a different type of gas other than the type shown on the rating plate. Such conversion could result in hazardous operating conditions. Please have a professional connect the gas pipe.

The manual gas appliance shut off valve must be installed at the gas connection of the water heater at the time of installation.

The branch gas supply line to the water heater should be clean black steel pipe or other approved gas piping material. A ground joint union or ANSI design certified semi-rigid or flexible gas appliance connector should be installed in the gas line close to the water heater.

The National Fuel Gas Code (NFGC) mandates a manual gas shut off valve, see (NFGC) for complete instructions.



DO NOT use excessive force (over 31.5 ft lbs) in tightening the pipe, particularly if pipe compound is used, as the unit may be damaged.

Compound used on the threaded joints of the gas piping must be of the type resistant to the action of propane gas. Use compound sparingly and use on male threads only.

A sediment trap should be installed at the bottom of the gas line.

The inlet gas pressure to the water heater must not exceed 14" w.c for propane gas. For purposes of input adjustment, the minimum inlet gas pressure (with main burner on) is shown on the water heater rating plate. If high or low gas pressures are present, contact your gas supplier for correction.

The appliance and its individual shut off valve must be disconnected from the gas supply piping system during any pressure testing of that system at test pressures in excess of 1/2 PSI (3.5 kPa). The appliance must be isolated from the gas supply piping system by closing its individual manual shut off valve during any pressure testing of the gas supply piping system at test pressures equal to or less than 1/2 PSI(3.5kPa).

The appliance must be isolated from the gas supply piping system by closing its individual manual shut off valve during any pressure testing of the gas supply piping system at test pressure equal to or less than 1/2 PSI (3.5kPa).

Leak Testing

⚠ WARNING: Never use an open flame to test for gas leaks, as property damage, personal injury, or death could result.

The water heater and its gas connections must be leak tested at normal operating pressures before it is placed in operation.

- Turn on the gas shut-off valves(s) to the water heater.
- Use a commercial leak detector or soapy water solution to test for leaks at all connections and fittings. Bubbles indicate a gas leak that must be corrected.

All connections should also be leak tested after the water heater is placed in operation.



Installing The Water Heater

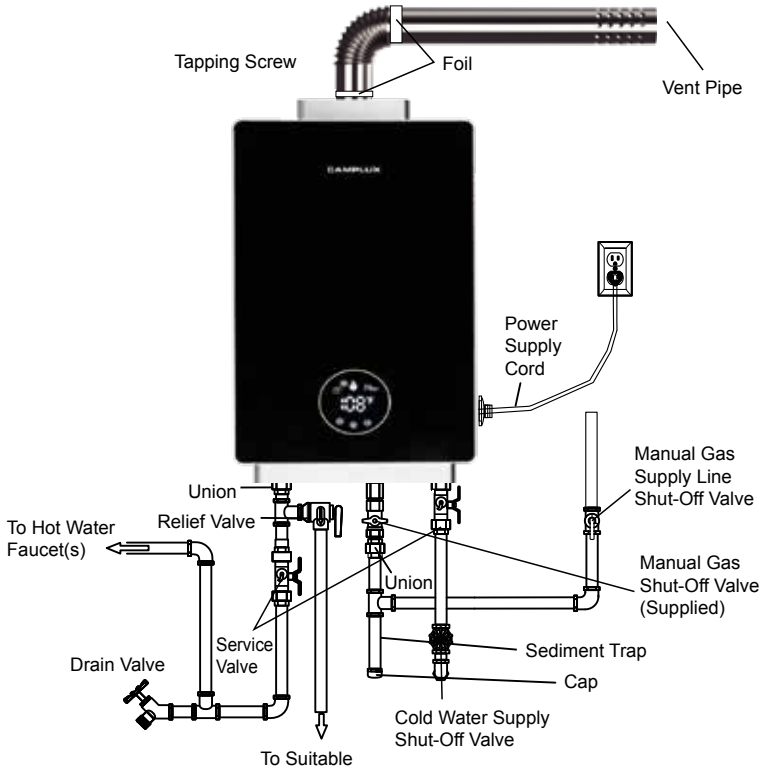

*Note: A flexible drain tube can be used

NOTICE: The National Fuel Gas Code (NFGC) mandates a manual gas shut off valve: See (NFGC) for complete instructions. Local codes or plumbing authority requirements may vary from the instructions or diagrams provided and take precedent over these instructions.

Pressure Testing The Gas Supply System

⚠ WARNING: Install a gas pressure regulator, in the gas supply line, which does not exceed the maximum supply pressure. DO NOT use an industrial type gas regulator.



The water heater must be isolated from the gas piping system by closing the manual gas shut off valve during any pressure testing of the gas supply piping at pressure equal to or less than 1/2 PSI (14' w.c.).

For Using Under High Altitude

Ratings of gas appliance are based on sea level operation and need not be changed for installations at elevations up to 2,000 feet/600 meter. Unit not recommended for elevations in excess of 2,000 feet/600 meter.

Mounting The Water Heater

Make sure the location of the appliance allows for easy access and operation. In case of dry wall or concrete wall use dry anchors or lad bolts. The water heater requires 120VAC/60Hz. Have a receptacle with ground terminal near the water heater. The length of the power supply cord is 5 feet. Drill the holes as per sizes in the figure to the left, put 2 expansion screws into the top holes, and 2 rubber screws into the bottom holes.

⚠ CAUTION: Reinforcement of the wall is required in case the wall is not strong enough to hold the appliance.

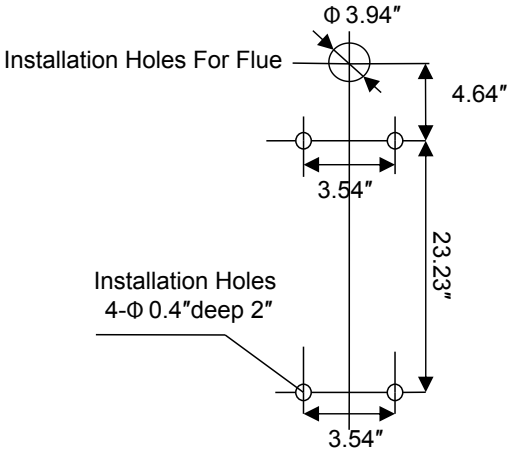

Indoor unit must be installed with Category III vent pipe in accordance with vent supplier/manufacture in accordance with local code.

A. BACK INSTALLATION

1. Insert the vent pipe through the installation holes in the wall with the terminal sticking out.
2. Connect the elbow to the vent pipe and water heater, moving straight backwards until the expansion screws go into the holes of the water heater. Screw the nuts tight (pay attention to the direction of the elbow.)

B. SIDE INSTALLATION

1. Aim the holes in the water heater onto the expansion screws, hang it up and screw the nuts tightly.
2. Put the vent pipe through the holes in the wall, and connect the elbow with the water heater and vent pipe.

C. VERTICAL INSTALLATION

Please refer to local installation professional or venting manufacturer:
The installation hole in the wall needs to be sealed by fire-retardant materials or wall thimble, making sure the water heater is tight and will not come off.

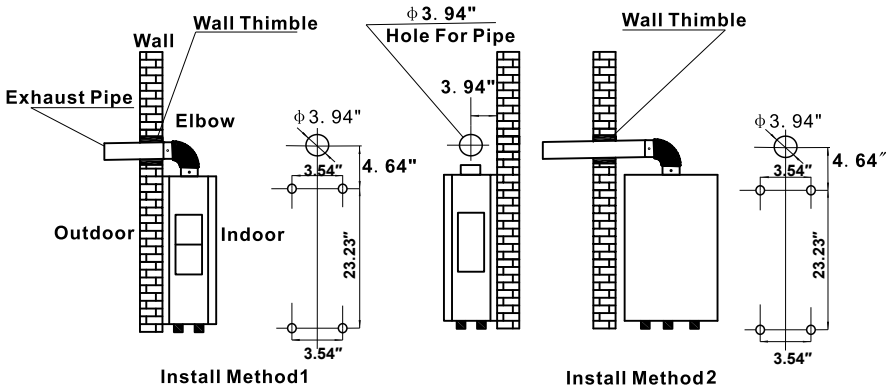

Installing The Water Heater

⚠ DANGER: Failure to install the vent adapter and properly vent the water heater to the outdoors as outlined in the venting section of this manual will result in unsafe operation of the water heater causing death, serious injury, explosion, or fire. To avoid the risk of fire. To avoid the risk of fire, explosion, or asphyxiation from carbon monoxide, NEVER operate the water heater unless it is properly vented and has adequate air supply for proper operation as outlined in the venting section of this manual.

⚠ WARNING: Use UL approved Category III stainless steel vent material only. No other vent material is permitted. Refer to page 18 for clearances to combustible material.

Venting

The installation of venting must comply with national codes, local codes, and the vent manufacturer's instructions.

The water heater must be vented to the outdoors as described in these instructions. DO NOT connect this water heater to an existing vent or chimney, it must be vented separately from all other appliances.

All vent components (adapters, pipe, elbow, terminals, etc.) should be UL 1738 Certified stainless steel venting materials (e.g. AL29-4C).

The specified vent termination must be used. The termination should be a 90° elbow type with screen. (Refer to page 26-27).

Use a vent pipe with an anti-disconnection structure.

The use of a high temperature silicone (500°F/260°C) may be required to seal vent connections. To prevent accidental gas exhaust leakage, apply a 1/4" wide bead approximately 1/4" from the end and another bead against to joint side of the stop bead.

Follow vent manufacturer's installation instructions.

The unit can be vented either horizontally or vertically.

Vent pipe runs must be adequately supported along both horizontal and vertical runs.

The maximum recommended unsupported span should be no more than 5 feet. Support isolation hanging bands should be used. DO NOT use wire (See diagram below).



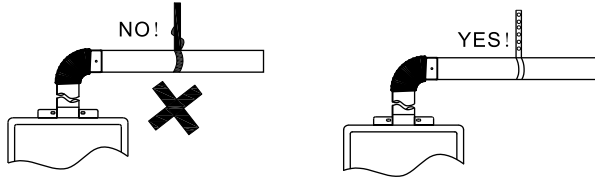

Venting Through Closed Spaces

If the vent piping passes through a closed space, wrap the vent pipe with inflammable insulation material that is at least 3/4" thick. DO NOT let the insulation material make contact with flammable materials. A minimum clearance of 6" between the vent pipe and ceiling should be maintained. Follow local codes. For maintenance and inspection purposes, the following holes are required to be made:

TWO (2) inspection openings that allow access to venting. One (1) of these openings should be close to where the vent pipe enters the ceiling. The other opening should be near the vent termination.

A ventilation hole with a 16 sq. in opening should be made at least every 10 feet.

NOTICE: Vent pipes must be completely insulated with inflammable material when installed with inflammable material when installed in alcoves, closets, and garages and must not touch any flammable material.

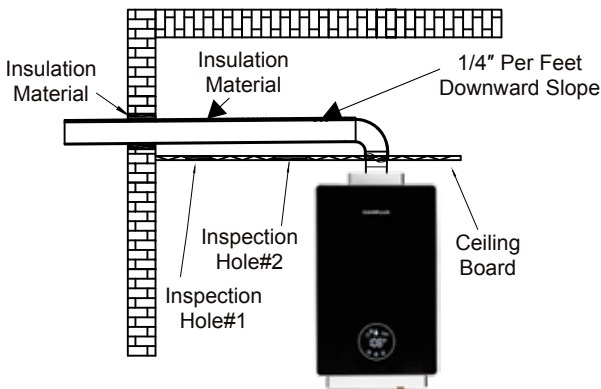

Venting Lengths

Maximum vent length

Owner must refer to vent manufacturer's instructions and specifications.

Number of 90° elbows(Bends)	Maximum length of straight pipe
1	32"
2	27"
2	22"
One(1)90° elbow is equivalent to 5 feet of straight pipe	

The system will not operate if there is excessive restriction (pressure drop) in the venting system. A maximum of 32 feet of vent pipe may be used provided there is only one 90° elbow in the system. If additional elbows are required: two elbows can be used with 27 feet, and three elbows can be used with 22 feet of vent pipe. A 90°elbow is equivalent to 5 feet of straight pipe. A 45°elbow is equivalent to 2 feet 6" of straight pipe.

The termination elbow does not count as an elbow when determining total vent lengths.

The vent must be installed with a slight downward slope of 1/4" per feet of horizontal run toward the vent terminal (see diagram below). This ensures that any condensate formed during operation of the unit is evacuated from the appliance.

A 1/4" per feet upward slope is acceptable when it is not possible to vent with a downward slope, however, a UL approved category III stainless steel condensate trap MUST be installed at the beginning of the horizontal run (see page 21 Typical Horizontal Termination with 1/4" per feet upward slope or page 17 Standard Vertical Vent Termination for examples).

Minimum vent length

The venting may be as short as 12" provided one vent termination is installed to the outdoors through a sidewall, one 90° elbow is included in the installation, and the wall thimble is installed.

NOTICE: Make sure that the seam of the vent pipe in horizontal runs is toward the top of the installation (see illustration below).



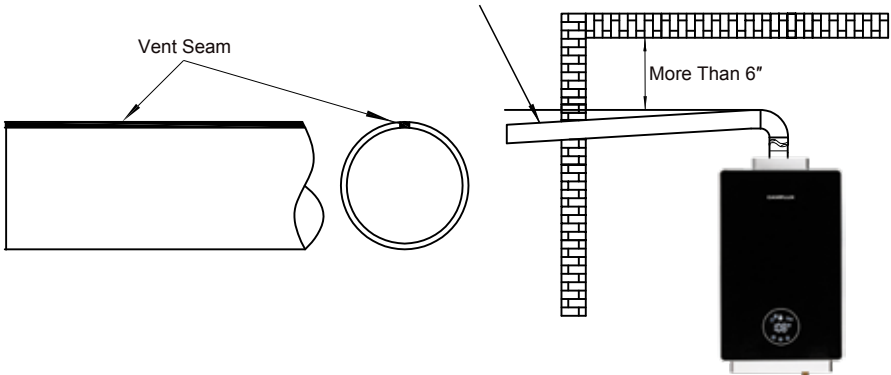

Draining the condensate

In certain conditions, installations in unconditioned space or having long horizontal or vertical runs may accumulate condensate.

Condensate is known to be acidic, refer to local state (provincial) or federal codes for proper handling methods.

In order to prevent condensate from draining back into the water heater, we recommend a condensate trap and drain to be installed in a horizontal vent section as close as practical to the water heater vent connection.

NOT following proper condensate procedures will void warranty.

Vent Termination Clearances Drawing

For non-direct vent installations in the US and Canada

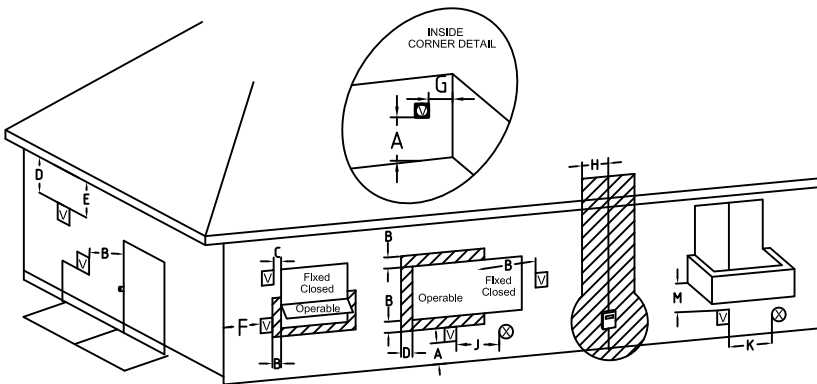

		US Installation 1	Canadian Installation 2
A=	Clearance above grade, veranda, porch, deck, or balcony	12 in (30 cm)	12 in (30 cm)
B=	Clearance to window or door that may be opened	4ft (1.2m) below or to side of opening: 1ft (300mm) above opening	6 in (15cm) for appliances ≤10,000 Btu/Hr (3kW), 12 in (30cm) for appliances > 10,000 Btu/Hr(3kW) and ≤ 10,000 Btu/Hr (30kW), 36 in (91cm) for appliance > 10,000 Btu/Hr (30kW)
C=	Clearance to permanently closed window	*	
D=	Vertical clearance to ventilated soffit located above the terminal within a horizontal distance of 2 feet (61cm) from the center line in terminal	*	
E=	Clearance to unventilated soffit	*	
F=	Clearance to outside corner	*	
G=	Clearance to inside corner	*	
H=	Clearance to each side of center line extended above meter/regulator assembly	*	3ft (91cm) within a height 15ft above the meter /regulator assembly
I=	Clearance to service regulator vent outlet	*	3 ft (91 cm)
J=	Clearance to non-mechanical air supply inlet to building or the combustion air inlet to any other appliance	4ft (1.2m) below or to side of opening: 1ft (300mm) above opening	6 in (15cm) for appliances ≤ 10,000 Btu/Hr (3kW), 12 in (30cm) for appliances > 10,000 Btu/Hr(3kW) and ≤ 10,000 Btu /Hr (30kW), 36 in (91cm) for appliance > 10,000 Btu/Hr (30kW)
K=	Clearance to mechanical air supply inlet	3ft (91cm) above if within 10ft (3m) horizontally	6 ft (1.83 m)
L=	Clearance above pave sidewalk or paved driveway located on public property	*	7 ft (2.13 m)
M=	Clearance under veranda, porch, deck or balcony	*	12 in (30 cm)

For clearances not specified in ANSI Z223.1/NFPA 54 or CSA-B149.1, one of the following shall be indicated:

- A) A minimum clearance value determined by testing in accordance with Clause 5.20 or,



B) A reference to the following footnote:

Clearance in accordance with local installation codes and the requirements of the gas supplier.

- A vent shall not terminate directly above a sidewalk or paved driveway that is located between two single family dwellings and serves both dwellings.
- Permitted only if veranda, porch, deck or balcony is fully open on a minimum of two sides beneath the floor.

NOTES:

1. In accordance with the current CSA B129.1 propane installation code.
2. In accordance with the current ANSI Z223.1/NFPA 54 National fuel gas code.

Installing The Water Heater, Continued

Pipe Installation

Inlet pipe and outlet pipe installation

Use pressure resistant pipe to connect the inlet and outlet water pipes of the water heater and the local water pipe (make sure to place the rubber ring). Before connecting the inlet water pipe, flush the inside of the pipe.

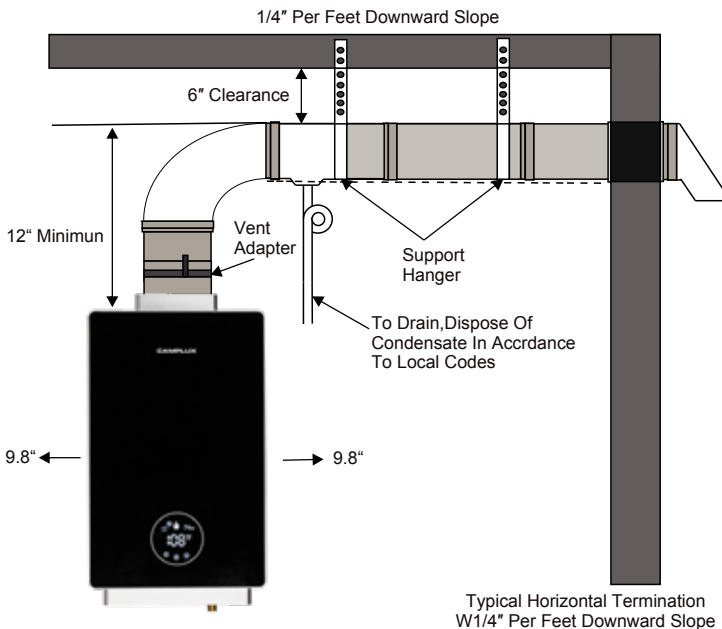

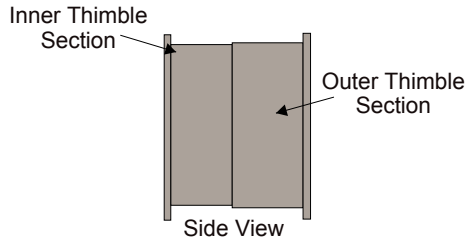

CAUTION

Follow the vent manufacturers installation instructions as design might vary from manufacturer to manufacturer.

WARNING

Field wiring connections and electrical grounding must comply with local codes, or in the absence of local codes with the latest edition of the National Electrical Code ANSI/NFPA 70, or in Canada, Canadian Electrical Code, CSA C22.1 Part1.

Use UL approved Category III vent material only. No other vent material is permitted. Owner must refer to vent manufacturer's instructions and specifications.

Hardwiring The Electrical Connections

- Wiring should be carried out by a qualified electrician in accordance with local codes.
- The water heater requires 120VAC/60Hz and should be properly grounded.
- DO NOT connect grounding wire to water pipes, gas pipes, telephone cables, lightning conductor circuits and to grounding circuit of other equipment that carry a ground-fault interrupter.
- An ON/OFF switch must be provided and installed for the incoming 120VAC power.
- Wire the water heater exactly as shown below. A wiring diagram is also found inside of the cover panel.
- A green screw is provided in the junction box for grounding connection.
- Connect the live wire to black leg wire and the neutral wire to the white neutral wire.

CAUTION

Label all wires prior to disconnection when servicing controls. Wiring errors can cause improper and dangerous operation. Verify correct operation after servicing.



Electric wiring diagram

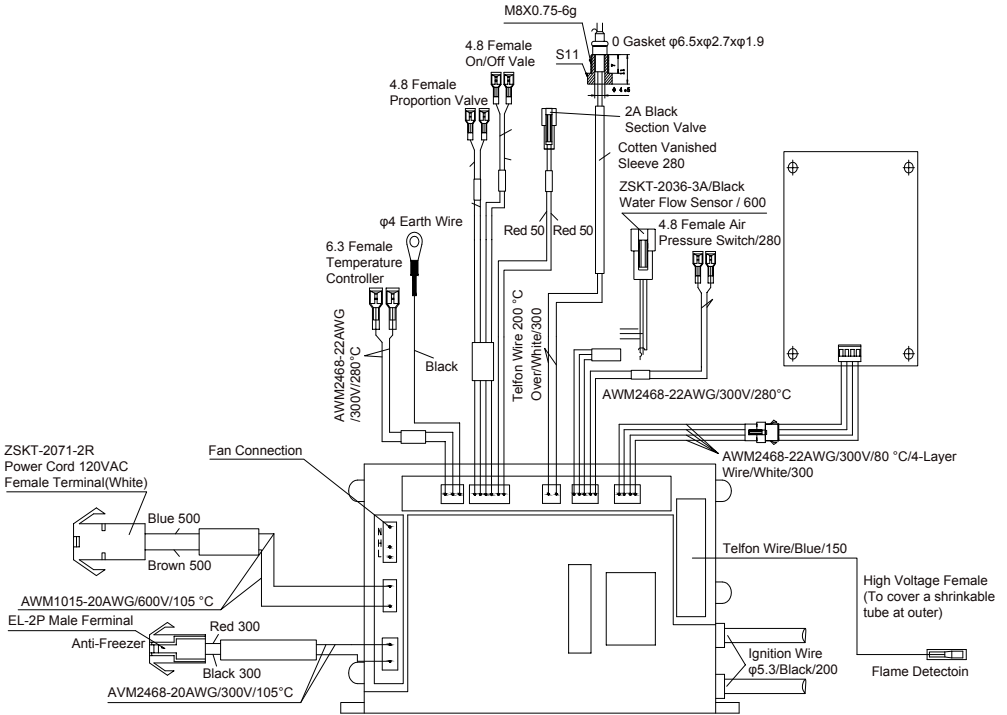

Electrical Connection

Power cord

- The electric power supply requirement for this water heater is 120VAC/60Hz, 2 Amps.
- The water heater comes with a three (3) pin power supply cord. Use only a power outlet with a ground terminal.
- The installation of an electric leakage breaker is recommended(GFCI)
- Keep any excess of the power supply cord on the outside of the water heater.
- If local codes require hardwiring, see instructions for “Hardwiring the electrical connections”.



WARNING

Shock hazard line voltage is present. Before servicing the water heater, turn off the electrical power to the water heater at the main disconnect or circuit breaker. Failure to do so could result in severe personal injury or death.

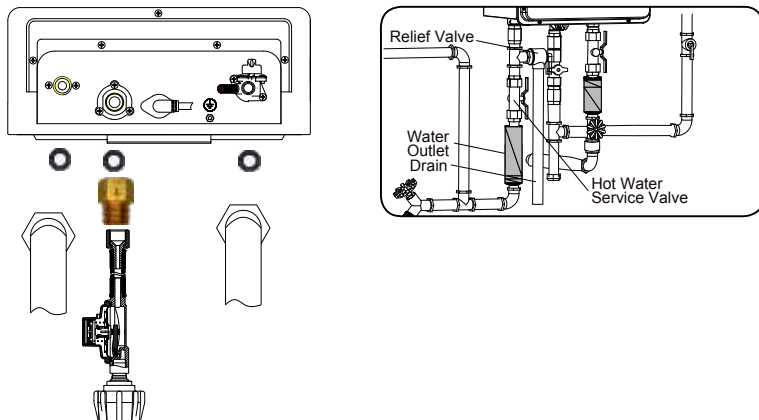

Hot and cold pipe insulation installation

For increased energy efficiency, use pipe insulation. Please install the insulation, according to the illustrations above, making sure to insulate all the way to the top. Do not cover any drain or pressure valve(s).

During installation of this water heater

MUST DO

- DO check inlet gas pressure to ensure that it is within the range specified on the rating plate.
- Do provide adequate air for combustion and ventilation as discussed in the Use and Care Manual and the National Gas Code (CAN/CGA B149 in Canada).
- DO maintain proper clearances to combustibles as specified by applicable code.
- DO ensure the flue terminal location complies with the guidelines found in the Use and Care Manual and the National Gas Code (CAN/CGA B149 in Canada).

DO NOT

- DO NOT block or restrict air intake opening located on the back side of the water heater.
- DO NOT remove the front cover unless absolutely necessary. This should only be done after being examined by a qualified service technician.
- DO NOT install this product where standing water may occur.



Installation check list

A. Water Heater Location

- Installed INDOORS.
- Close to area of mostly used outlet.
- Protected from freezing temperatures.
- Proper clearance from combustible surfaces observed.
- Sufficient fresh air supply for proper operation of water heater.
- Air supply free of corrosive elements and flammable vapors.
- Provisions made to protect area for water damage.
- Sufficient room to service heater.
- Combustible materials, such as clothing, cleaning materials, rags, etc. clear of the heater and vent piping.
- Water heater is properly attached to the wall.

B. Water Supply

- Water supply has sufficient pressure.
- Air purged from water heater and piping.
- Water connections tight and free of leaks.
- Water filter is clean and in place.
- Materials used are as instructed in this manual.
- Water pipes are insulated.

C. Gas Supply

- Gas type matches rating plate.
- Gas supply pressure is sufficient for the water heater.
- Gas line equipped with shut-off valve, union and sediment trap.
- Approved pipe joint compound used.
- Commercial leak detector or soap and water solution used to check all connections and fittings for possible gas leak.
- Gas company inspected installation (if required).

D. Relief Valve

- Pressure relief valve properly installed and discharge line run to open drain.
- Discharge line protected from freezing.

E. Electrical Wiring

- Voltage matches rating plate.
- Water heater is properly grounded.
- Wiring meets all local codes.
- GFCI protection where required.



Lighting The Water Heater

Before operating this water heater, be sure to read and follow the instructions on the label pictured below and all other labels on the water heater, as well as the warnings printed in this manual. Failure to do so can result in unsafe operation of the water heater resulting in property damage, personal injury, or death. Should you have any problems reading or following the instructions in this manual. STOP! Get help from help from Camplux at www.camplux.com ,live chat and toll free at (844)538-7475.

Operating The Water Heater

Turning on the water heater

1. Make sure the gas type you will use is same as the type on the data plate.
2. Turn on the main gas valve, plug in the power cord (be sure the socket is well grounded), and press the "ON/OFF" button on the control panel. Set temperature to 120°F(49°C).
3. Turn on the faucet, and the fan will begin working. You will hear the ignition sound after a few seconds. The burner will ignite, and hot water will come out. If the burner is not ignited successfully, the ignition sound will last a few seconds. If the burner still fails to ignite, turn off the faucet and wait for 10-20 seconds, and repeat the above procedures.

For first use and/or if the water heater has not been used for a considerable period of time, the repeat of the above procedures may be required, due to accumulated air inside the gas pipe.

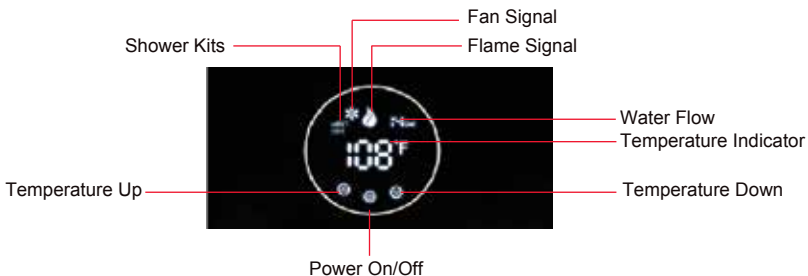

NOTE: Press and hold "Temperature Up" and "Temperature Down" button at the same time for 3 seconds, you can switch the temperature from Fahrenheit to Celsius. Or you can repeat to press and hold for 3 seconds if want to change back to Fahrenheit.



Safety precaution

If there is any difficulty in understanding or following the operating instructions or the Care and Cleaning section, it is recommended that a qualified person or serviceman perform the work.

- DO turn off manual gas shut-off valve if water heater has been subjected to over-heating, fire, flood, physical damage or if the gas supply fails to shut off.
- DO NOT turn on water heater unless water and gas supplies are fully opened.
- DO NOT turn on water heater if cold water supply shut-off valve is closed.
- DO NOT allow combustible materials such as newspaper, rags or mops to accumulate near water heater.
- DO NOT store or use gasoline or other flammable vapors and liquids, such as adhesives or paint thinner, in vicinity of this or any other appliance. If such flammables must be used, open doors and windows for ventilation, and all gas burning appliances in the vicinity should be shut off including their pilot lights, to avoid vapors lighting.

NOTICE: Flammable vapors can be drawn by air currents from surrounding areas to the water heater.

Water Temperature Setting

DANGER! Water temperature setting

Safety and energy conservation are factors to be considered when selecting the water temperature setting. Water temperatures above 125°F(52°C) can cause severe burns or death from scalding. The thermostat is adjusted to its lowest temperature position when shipped from the factory. Be sure to read and follow the warnings outlined on the label pictured below.

DANGER

There is a hot water scald potential if the temperature is set too high. Households with small children, disabled, or elderly persons may require a 120°F(49°C) or lower temperature setting to prevent contact with HOT water.

Be sure to read and follow the warnings outlined in this manual and on the label located on the water heater. Mixing valves are available for reducing point of use water temperature by mixing hot and cold water in branch water lines.

Before manually operating the relief valve, make certain no one will be exposed to the danger of the hot water released by the valve. The water may be hot



enough to create a scald hazard. The water should be released into a suitable drain to prevent injury or property damage. Procedures for adjusting the thermostat for energy efficient operation at the minimum water temperature setting consistent with the consumer's needs. Contact a licensed plumber or the local plumbing authority for further information.

Time/Temperature Relationship in Scalds		
Water Temperature		Time To Produce a Serious Burn
120°F	49°C	More than 5 minutes
122°F	50°C	1 1/2 to 2 minutes
130°F	54°C	About 30 seconds
135°F	57°C	About 10 seconds
140°F	60°C	Less than 5 seconds
145°F	63°C	Less than 3 seconds
150°F	66°C	About 1 1/2 seconds
155°F	68°C	About 1 second

Table courtesy of shriners burn institute

The chart shown above may be used as a guide in determining the proper water temperature for your home.

Set temperature memory

- This water heater contains an electronically controlled thermostat. From the factory, the temperature range is between 95°F(35°C) and 149°F(65°C).
- When the unit is in use, press the up button on the control panel every time and the temperature will rise 34°F(1°C), on the contrary, it will decrease by 34°F(1°C).
- The display will read the set temperature if the water heater is not in use or there is no water flow. If the water is in use or has water flow, the display will read the actual temperature. To view the set temperature in this condition, press UP or DOWN and the set temperature will flash 3 seconds.
- The hottest temperature water will be at the hot water faucet closet to the water heater.
- Always supervise young children or others who are incapacitated.
- If the water heater has been subjected to fire, flood or physical damage, turn off the manual gas shut off valve(s), and do not operate the water heater again until it has been checked by qualified personnel.



⚠️ WARNING: Should overheating occur or the gas supply fail to shut off, turn off the manual gas control valve to the appliance.

Care And Cleaning Of The Water Heater

Routine Preventative Maintenance

⚠️ DANGER: Before manually operating the relief valve, make certain no one will be exposed to the danger of the hot water heater by the valve. The water may be hot enough to create a scald hazard. The water should be released into a suitable drain to prevent injury or property damage.

⚠️ DANGER: Hotter water increases the potential for hot water scalds.

⚠️ DANGER: Failure to perform the recommended routine preventative maintenance can harm the proper operation of this water heater, which can cause carbon monoxide dangers, excessive hot water temperatures and other potentially hazardous conditions.

Properly maintained, your water heater will provide years of dependable trouble free service. It is recommended that a periodic inspection of the burner, relief valve, water filter and venting system should be made by service personnel qualified in gas appliance repair.

It is suggested that a routine preventive maintenance program be established and followed by the user.

At least once a year, lift and release the lever handle on the pressure relief valve, located in the hot outlet piping of the water heater, to make certain the valve operates freely. Allow several gallons to flush through the discharge line to an open drain.

Rapid closing of faucets or solenoid valves in automatic water using appliances can cause a banging noise heard in a water pipe. Strategically located risers in the water pipe system or water hammer arresting devices can be used to minimize the problem.

Inspect the area around the water heater to ensure a safe operating environment. Keep appliance area clear and free from combustible materials, gasoline, and other flammable vapors and liquids. Ensure the unit has not been damaged. If damage or denting is present, contact a service personnel to verify proper operation.

Check for any abnormal sounds during normal operation of the water heater.

All piping should be checked for gas and/or water leaks. Refer to page 14 of this manual for instructions on leak testing.



The air intake and cold water supply filters should be cleaned monthly. Refer to page 30 “Maintenance” for further information.

DO NOT operate the water heater if you feel something is wrong with the unit.

DO NOT allow children to operate or otherwise handle the unit.

NOTICE: If the pressure relief valve on the hot water heater discharges periodically, this may be due to a problem in the water system. Contact the water supplier or your plumbing contractor on how to correct this.

DO NOT plug the relief valve outlet.

NOTICE: After inspection, maintenance, and/or cleaning, ensure proper operation by turning on a hot water faucet.

Maintenance

Before performing any maintenance tasks to this water heater, be sure to turn the unit off and disconnect the power supply.

Vacuum around the water heater for dust, dirt and lint on a regular basis. Clean the water heater and remote control by using a damp soft cloth with a few drops of mild detergent and gently wiping the surfaces of the unit. Wipe any remaining moisture with a dry soft cloth.

To ensure sufficient ventilation and combustion air supply, proper clearances must be maintained. The water filters should be cleaned on a monthly basis.

⚠ DANGER: Shock hazard. Make sure the electrical power to the water heater is off to avoid potential serious injury or damage to components.

⚠ DANGER: Combustible materials, such as clothing, cleaning materials, or flammable liquids, etc., must not be placed against or next to the water heater.

How to clean the water heater

1. Make sure the unit is OFF and the electrical power supply has been disconnected.
2. Turn the water supply OFF to the heater.
3. Unscrew the water filter, and slide the filter out.
4. DO NOT tap the filter as it may deform and/or damage the filter.
5. To remove severe dust, use a soft brush and wash with running water.
6. Return the filter to the water heater and screw in the filter.
7. Turn the electrical power supply and cold water supply ON to the water heater.



8. Use only mild soapy water, other cleaners may damage the surface of the water heater.
9. DO NOT remove any label including the rating plate while cleaning or servicing.

NOTICE: DO NOT block or obstruct the air intake opening located at the lower left corner of the water heater. A minimum of 12" is required between this combustion air inlet opening and any obstruction.

Venting system inspection

The venting system should be inspected annually to ensure all of the vent sections are secure and airtight.

It is recommended that qualified service personnel familiar with Category III venting inspect the venting system.

Check vent connection joint sections with a solution of soapy water to assure air tightness while the unit is operating. Bubbles around a joint connection indicates a seal leak. Refer to page 18 for vent sealing instructions.

DO NOT operate the unit if vent system shows signs of leaking exhaust.

Check to make sure that the air intake and the vent terminal have not been blocked or contain debris.

Vacation and extended shut-down

If the water heater is to remain idle for an extended period of time, the power and water to the appliance should be turned off.

The water heater and piping should be drained if they might be subjected to freezing temperatures.

After a long shut-down period, the water heater's operation and controls should be checked by qualified service personnel.

Not Equipped With Anti-freezing Protection

Draining procedure

When the temperature falls below 32°F(0°C), water in your plumbing system or water heater can turn to ice and then expand causing damage to the water heater. This damage is not covered under your manufacturer's warranty. If these conditions are anticipated, please drain the water heater as follows to help but not guarantee from freezing:



1. Shut off the main gas valve and power
2. Shut off the inlet water valve
3. Open all faucets
4. Take off the drain valve, and allow water to drain for 3 minutes or until the units is empty.
5. Making sure all water is out, replace the drain valve, and shut off the faucets.

Care And Cleaning Of The Water Heater

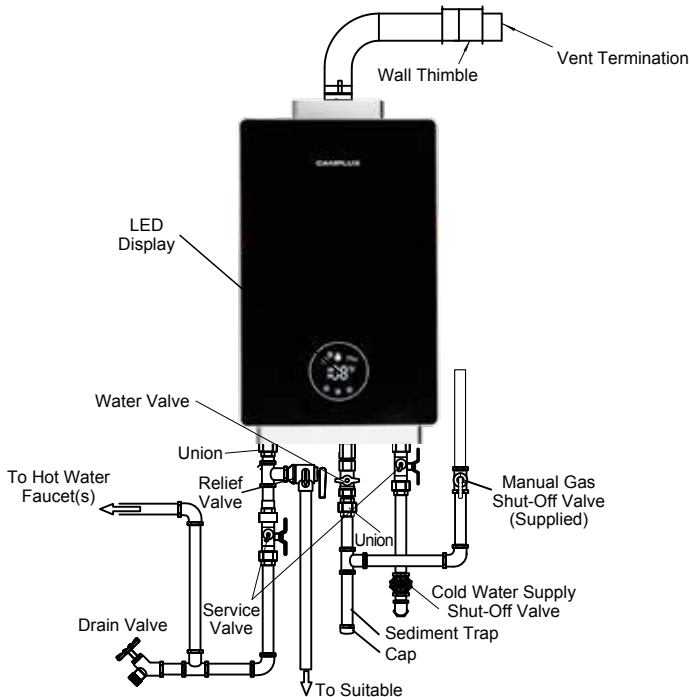

Below are instructions for draining water out of the water heater.

1. Close the gas shut off valve(s).
2. Close the water shut off valve.
3. Turn the on/off switch to the OFF position and disconnect breaker at least 10 seconds after step #1.
4. Open drain valve.



5. Open all hot water faucets. Before proceeding to the next step, make sure that COLD water is coming out of all hot water faucets.
6. To put the water heater back into operation after draining, follow the steps below.
7. Reinstall the water filter. Close the hot water outlet drain valve.
8. Open the water shut-off valve and close again after making sure that water comes out from hot water faucets. (This step is to remove air from the water lines).
9. Reconnect the breaker and turn the on/off switch to the ON position, fully open the gas shut off valve and the water shut off valve.

NOTICE: The water heater may not operate unless the above procedure is followed correctly.

Before You Call For Service

Troubleshooting tips

Save time and money! Review the charts on the following pages first and you may not need to call for service.

This water heater incorporates a variety of shut off devices that prevents the operation of the water heater down if undesirable combustion condition occurs.

Problem	Possible Cause	What To Do
Not enough or no hot water	Water shut off valve is not fully opened	Check shut off valve and open fully
	Hot water faucet is not fully opened	Open hot water faucet completely (the main burner goes off when incoming water volume is inadequate)
	Water piping is frozen	Allow piping too thaw
	No electricity or water supply is cut off	Check that proper power is being supplied and or water supply is adequate
	Unit is "ON"	Turn the unit "ON" by the button on the remote control
	The temperature may be set too low	Increase the temperature setting
	Mixing valve malfunction (if applicable)	Check and replace if necessary
Water not hot enough	The temperature may be set too low	Increase the temperature setting
	The gas valve is not fully opened	Check and open the gas valve fully
Water too hot	The temperature is set too high	Decrease the temperature setting
	Water shut off valve is not fully opened	Check shut off valve and open fully
	Small amount water has been heated	Allow more water to flow
	Water filter is clogged	Clean the filter with a booth brush
Fan continues to rotate after hot water faucet is closed	This function is no purge un-burned gas 10-15 seconds	Normal operation. There is no need to call for service. Check for error codes



Error code guide

When an error code is displayed :

1. Close the hot water faucet, turn off the switch on the remote control.
2. Wait for about 5 minutes before turning the switch on again.
3. Open the hot water faucet.

If error code remains down:

1. Close the hot water faucet and turn off the switch on the remote control.
2. Take the proper action shown below and attempt operation of the appliance again.

If the error code still shown:

1. Turn off the hot water faucet and turn off the switch on the remote control.
2. Take care of the error code displayed and contact customer service at (844)538-7475 or email to support@camplux.com for any assistance.

Error Code	Error Description	Possible Cause	How To Do
E0	Hot water sensor failure	Junction pot loose, short circuit.	Call for service.
E1	Ignition system failure	The gas valve is not opened or fully opened. Water shut off valve is not open. Junction port loose.	Check and open gas fully. Check and open water valve. Call for service.
E2	Flame failure protection	Failure to detect the flame.	Check if gas off /empty tank. Check if the flame sensor damaged.
E3	Over-heating protection	Dry Combustion. Problem of over heating controller.	Call for service.
E5	Pressure switch	Motor Problem, voltage of power supply is too low.	Call for service.
E7	Solenoid valve	Open circuit of the valve ,short circuit of the valve, none of the above.	Connect the valve, replace the valve, replace the PCB board.
E8	Residual fire issue	Solenoid or PCB controller malfunction.	Call for service.

⚠ CAUTION: For your safety DO NOT attempt repair of gas piping, remote control, burners, vent connectors or other safety devices. Refer repairs to qualified service personnel.

⚠ CAUTION: Make certain power to water heater is “OFF” before removing protective cover FOR ANY REASON.

⚠ CAUTION: Label all wires prior to disconnection when servicing controls. Wiring errors can cause improper and dangerous operation. VERIFY PROPER OPERATION AFTER SERVICING.



Replacement Parts And Drawing

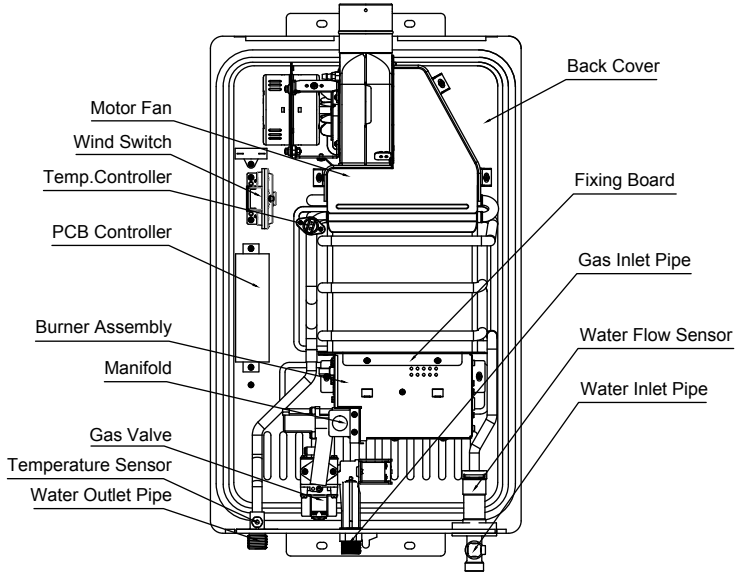



CAMPLUX			
RESIDENTIAL TANKLESS WATER HEATER			
Model No.	CA318B/CA318W	Maximum Input Rating (Btu per hour)	82,000
Serial No.		Minimum Input Rating (Btu per hour)	28,700
Gas Type	Liquid Propane Only	Minimum Input Gas pressure	9.8" w.c (2.45Kpa)
Voltage	120 Volts	Maximum Input Gas pressure	12.4" w.c (3.10Kpa)
Frequency	60 Hz	Manifold Pressure	11.0" w.c (2.75Kpa)
Amps	Less than 12 Amperes	Maximum Working Pressure	150 PSI
Recovery Rating	As used in this standard, the quantity of water obtained by multiplying the manufacturer's input rating in Btu per hour by the thermal efficiency and dividing the product by 825 Btu per gallon. This is based on a 100°F temperature rise, and a nominal specific heat for water of 8.25 Btu per gallon per degree F.		
Not recommended in excess of 2,000 ft. above sea level.		Category III Water Heater	
FOR YOUR SAFETY Do not store or use gasoline or other flammable vapors and liquids in the vicinity of this or any other appliance For customer service on this appliance contact: support@camplux.com 1(844)538-7475			
The unit must be installed on a fire retardant area, and must be away from all combustible materials. Minimum clearances from combustible construction, 6 inches sides, 0 inches back and 12 inches top.			
The temperature and pressure relief valve provided by the manufacturer shall be installed at the time of installation of the heater in the location specified by the manufacturer. Local codes shall govern installation of relief devices. For safe operation of the water heater, the relief valve must not be removed or plugged.			
This water heater requires a special venting system. Refer to the installation instructions for parts list and method of installation.			
CAMPLUX			

CAMPLUX			
RESIDENTIAL TANKLESS WATER HEATER			
Model No.	CA318B/CA318W	Maximum Input Rating (Btu per hour)	82,000
Serial No.		Minimum Input Rating (Btu per hour)	28,700
Gas Type	Natural Gas Only	Minimum Input Gas pressure	6.0" w.c (1.50Kpa)
Voltage	120 Volts	Maximum Input Gas pressure	8.0" w.c (2.0Kpa)
Frequency	60 Hz	Manifold Pressure	7.0" w.c (1.74Kpa)
Amps	Less than 12 Amperes	Maximum Working Pressure	150 PSI
Recovery Rating	As used in this standard, the quantity of water obtained by multiplying the manufacturer's input rating in Btu per hour by the thermal efficiency and dividing the product by 825 Btu per gallon. This is based on a 100°F temperature rise, and a nominal specific heat for water of 8.25 Btu per gallon per degree F.		
Not recommended in excess of 2,000 ft. above sea level.		Category III Water Heater	
FOR YOUR SAFETY Do not store or use gasoline or other flammable vapors and liquids in the vicinity of this or any other appliance For customer service on this appliance contact: support@camplux.com 1(844)538-7475			
The unit must be installed on a fire retardant area, and must be away from all combustible materials. Minimum clearances from combustible construction, 6 inches sides, 0 inches back and 12 inches top.			
The temperature and pressure relief valve provided by the manufacturer shall be installed at the time of installation of the heater in the location specified by the manufacturer. Local codes shall govern installation of relief devices. For safe operation of the water heater, the relief valve must not be removed or plugged.			
This water heater requires a special venting system. Refer to the installation instructions for parts list and method of installation.			
CAMPLUX			

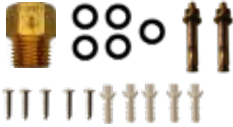

In The Box

Item	Description	Identification	Quantity
A	Residential tankless water heater		1 piece
B	Vent pipe (Φ2.0"x20")		1 set
C	Fixing kits		1 set
D	Manual		1 piece



Camplux, Enjoy Outdoor Life! Limited Warranty Information

Camplux hereby warrants this product to be free of material defects in materials and workmanship when installed and operated according to Camplux's installation and operating instructions. This Limited Warranty extends to the original purchaser and subsequent owners, but only while the product remains as the site of the original installation. This Limited Warranty terminates if moved or reinstalled at a new location. There are no warranties, express or implied made or given other than contained in this Limited Warranty. No agent, employee or representative of Camplux has any authority to bind Camplux to any representation or warranty concerning the Product not contained in this Limited Warranty.

as expressly set forth herein, THERE ARE NO REPRESENTATIONS OR WARRANTIES, EXPRESS OR IMPLIED, INCLUDING, WITHOUT LIMITATION, AS TO MERCHANTABILITY OR FITNESS FOR A PARTICULAR PURPOSE WITH RESPECT TO ANY GOODS SOLD HEREUNDER. BUYER'S EXCLUSIVE REMEDY IS LIMITED TO REPAIR OR REPLACEMENT OF THE GOODS SOLD, AT CAMPLUX'S DISCRETION. CAMPLUX'S SHALL NOT BE LIABLE FOR INCIDENTAL OR CONSEQUENTIAL DAMAGES.

Item Period of Coverage

Heat Exchanger 1 year

All other parts 1 year

Free Accessories (Showerhead,hose,regulator etc) 30 days

Coverages are void if the unit is used in a hot water circulation loop, in series with a circulation system or where an on-demand recirculation system is not incorporated.

Owner is responsible for all other costs incidental to repair such as labor, shipping, delivery and permits. Proof of purchase required. Products repaired will be covered under this Limited Warranty for the remainder of term of the original purchase.

This Limited Warranty becomes null and void if any of the following are determined to be a contributing factor to the failure of the product:



1. Abuse, misuse, alteration, neglect or misapplication.
2. Improper or inadequate maintenance.
3. Inadequate water quality.
4. Installation in a corrosive or otherwise destructive environment.
5. Freeze Damage.
6. Scale buildup.
7. Incorrect gas or water pressure.
8. Acts of force Majeure.

This Product is not to be used as a pool or spa heater.

Within the first 30 days of purchase, Camplux will cover all ground shipping costs for warranty related issues, excluding AK, HI, Canada, and any location outside of the continental US. After the first 30 days of purchase, Camplux will cover all shipping costs to the customer for warranty related issues, excluding AK, HI, Canada, and any location outside of the continental US. After the first 30 days of purchase, the customer is responsible for all shipping to Camplux, regardless of reason or circumstance. The method for warranty related shipping will be Ground equivalent with the provider of Camplux's choosing.

AK, HI, Canada, and any location outside of the continental US, will be responsible for all shipping costs, regardless of reason or circumstance.

All shipments of any type of product coming to Camplux for any reason must have an RGA for any repairs to be made. Please contact Camplux to obtain an RGA number prior to shipping anything to Camplux. Failure to do so could result in loss of product. Camplux will not be responsible for replacement due to loss or damage if these steps are not properly followed.



Our Other Residential Models

CM264



CA528



WA686



	CM264	CA528	WA686
Use For	INDOORS ONLY	INDOORS ONLY	OUTDOORS ONLY
BTU	68,000	150,000	180,000
Flow Rate	Rated 2.64 GPM	Rated 5.28 GPM	Rated 6.86 GPM
Portable	No	No	No
Power Source	120 volts	120 volts	120 volts
Gas Type	Liquid Propane & Natural Gas	Liquid Propane & Natural Gas	Liquid Propane & Natural Gas
Water Pressure	3.6 - 150 PSI	7.0 - 150 PSI	3.6 - 145 PSI
Regulator & Hose	Standard/Not Included	Standard/Not Included	Standard/Not Included
Temperature Control	Manual 80 - 160°F	Manual 90 - 140°F	Manual 90 - 140°F
Warranty	1 Year	1 Year	1 Year
Product Dimensions	12.8*20.28*5.91 Inch	14*22.2*5.9 Inch	15*6.5*22.24 Inch

RESIDENTIAL SERIES



 1(844) 538-7475

 support@camplux.com

 Visit Us: Camplux.com

 8350 Patriot Blvd STE B, North Charleston, SC 29420

